

# RK12E Side-Entry Bathing Tub

## PRODUCT MANUAL



**NOTHING'S MORE REFRESHING THAN RANE**

## **IMPORTANT SAFETY INSTRUCTIONS**

### **PERTAINING TO A RISK OF FIRE, ELECTRIC SHOCK, FETAL INJURY, DROWNING, HYPERTHERMIA, OR INJURY TO PERSONS**

#### **READ AND FOLLOW ALL INSTRUCTIONS**



**WARNING: RISK OF FETAL INJURY;** Pregnant or possibly pregnant women should consult a Physician before using a hydromassage bathtub equipped with a heater.



**WARNING: RISK OF ELECTRIC SHOCK.**

- The unit must be connected to a supply circuit that is protected by a Ground-Fault Circuit-Interrupter (GFCI) installed by a qualified service representative or Licensed Electrician.
- Install this unit in accordance with the Canadian Electric Code, part I. the control provided with this unit shall be installed out of reach of persons occupying the tub in accordance with the Canadian Electrical Code , part I "*for unit with a control not integral with the tub.*"
- Do not permit electrical appliances (such as a hair dryer, lamp, telephone, radio, or television) within 5 feet or 1.5 meters of this hydromassage bathtub.
- GFCI should be tested on a routine basis. To test the GFCI, push the test button. The GFCI should interrupt power. Push the reset button. Power should be restored. If the GFCI fails to operate in this manner, the GFCI is defective. If the GFCI interrupts power without the test button being pushed there is ground current flowing, indicating the possibility of an electric shock. Do not use this hydromassage bathtub. Disconnect the hydromassage bathtub and have the problem corrected by a qualified service representative or Licensed Electrician before using.



**WARNING: RISK OF ACCIDENTAL INJURY AND DROWNING;**

- Children should not use hydromassage bathtub without adult supervision.
- Do not use hydromassage bathtub unless all suction guards are installed to prevent body hair entrapment.
- Do not use drugs or alcohol before or during the use of the hydromassage bathtub equipped with heater to avoid unconsciousness and possible drowning.
- People using medications and/or having an adverse medical history should consult a Physician before using a hydromassage bathtub equipped with a heater.



## **WARNING: RISK OF HYPERTHERMIA**

- Do not use a hydromassage bathtub equipped with a heater immediately following strenuous exercise.
- Water temperature in excess of 100° Fahrenheit or 38° Celsius may be hazardous to your health. Check and adjust water temperature before use.
- Prolonged immersion in water hotter than normal body temperature may introduce hyperthermia.
- Symptoms of Hyperthermia;
  - Heat stroke can be life-threatening and victims can die. A person with heat stroke usually has a body temperature above 104° Fahrenheit. Other symptoms include confusion, combativeness, bizarre behavior, faintness, staggering, strong and rapid pulse, and possible delirium or coma. High body temperature is capable of producing irreversible brain damage.
  - Heat fatigue is a feeling of weakness brought on by high outdoor temperature. Symptoms include cool, moist skin and a weakened pulse. The person may feel faint.
  - Heat syncope is a sudden dizziness experienced after exercising in the heat. The skin appears pale and sweaty but is generally moist and cool. The pulse is weakened and the heart rate is usually rapid. Body temperature is normal.
  - Heat cramps are painful muscle spasms in the abdomen, arms, or legs following strenuous activity. Heat cramps are caused by a lack of salt in the body.
  - Heat exhaustion is a warning that the body is getting too hot. The person may be thirsty, giddy, weak, uncoordinated, nauseated and sweating profusely. The body temperature is normal and the pulse is normal or raised. The skin is cold and clammy.



**WARNING:** Do not permit children to use this unit unless they are closely supervised at all times.



**WARNING:** Exercise care when entering or exiting the hydromassage bathtub.



**WARNING:** Use this unit only for its intended use as described in this manual. Do not use attachments unless recommended by the manufacturer.



**WARNING:** Do not drop or insert any objects into any openings.



**WARNING:** Do not operate this unit without the guard over the suction fitting.



**WARNING:** Service or repair work needed for this hydromassage bathtub other than normal cleaning or care should be performed by an authorized and qualified service representative.

**SAVE THESE INSTRUCTIONS**

Thank you and congratulations on becoming a “RANE” customer!

This manual is intended to ensure that the equipment performs to your satisfaction. The following information is crucial to the proper operation of the equipment, and will allow for a great bathing experience for both the caregiver and the one being cared for.

If there are any questions during the installation or operation of this unit, please contact your local Authorized Rane Dealer / Distributor, or Rane Bathing & Accessibility at 888-880-7373.



**This symbol is used throughout this manual to highlight items of importance or safety. Please pay particular attention to these items to ensure proper and safe operation of the equipment.**

## Table of Contents

Technical Specifications .....	Section 1
Pre-Installation Drawings and Dimensions .....	Section 2
Installing the Tub .....	Section 3
Using the Tub .....	Section 4
Warranty and Disclaimer .....	Section 5
Maintenance and Adjustments .....	Section 6
Troubleshooting .....	Section 7
Door Replacement Parts List .....	Section 8
Air Spa System .....	Section 9

# Technical Specifications

**Description:** Model RK12E is a freestanding, side-entry accessible bathtub.

**Construction:** The tub shell consists of a 3/16” thick fiberglass-reinforced polyester laminate. Critical areas are reinforced with a 1/4” thick core of end-grain balsa and additional layers of fortifying laminate. The sanitary gelcoat is an ISO/NPG type-finish.

**Thermostatic Mixing Valve** with anti-scald protection that dispenses 15 gallons per minute for fast tub fill.

**Handheld Shower Wand** for hair and upper body washing, which can be used at the same time the tub is filling.

**Analog Thermometer** for monitoring tub-fill and shower wand temperatures.

**Lap and Shoulder Harness** for resident safety.

**Secondary Door Lock** to prevent accidental door opening when in use.

**3/4” Supply Lines** constructed of stainless steel.

**CleanRane™ Air Spa System (if equipped)** with variable settings that enhance the therapeutic and relaxing effects of bathing for the resident.

Width:	<b>32”</b>
Length:	<b>61.5”</b>
Height (to top of tub spout):	<b>45” (lowest setting)</b>
Height (to top of door):	<b>35” (lowest setting)</b>
Adjustable leveling legs:	<b>2” maximum</b>
Seat width (interior):	<b>21.5”</b>
Seat height:	<b>19” (lowest setting)</b>
Threshold height:	<b>11” (lowest setting)</b>
Transfer device access:	<b>7” H X 44” W (lowest setting)</b>

Weight capacity (resident):	<b>600 lbs. / 272.7 kg</b>
Water capacity (occupied):	<b>48 gallons / 181.6 L</b>
Fill time (approx.):	<b>3 minutes, 12 seconds</b>
Drain time (approx.):	<b>1 minute, 58 seconds</b>
Water supply inlet:	<b>3/4” diameter</b>
Drain size:	<b>1.5”</b>
Electrical supply:	<b>115V AC; 60Hz; 15 amp (GFCI outlet required)</b>
Door configuration:	<b>Outward swing, Right Hinge only</b>

## Manufacturing and Testing

This unit is manufactured in Sparta, Tennessee, USA. Each unit passes a thorough quality control review and is tested for proper operation prior to shipping.

## Warranty

Please reference section 5 for complete warranty details.

**Certifications / Standards:** A112.19.7-2012 / CSA B45.10-12 / UL 1795 / CSA C22.2 no. 218.2  
IAPMO Z124-2011 / CSA B45.5-11

# Pre-Installation Drawings and Dimensions

FRONT VIEW



Vertical dimensions are with the tub in the lowest position. The seat height is 19" if legs are extended and tub is raised, adjust the dimensions accordingly

ANGLED VIEW



Note: To outside of Door

Allow 41" for door swing



Door hinge on right side of tub only. Verify placement and door swing before final placement of unit.

# Pre-Installation Drawings and Dimensions

## PLUMBING VIEW



All connections made through access opening provided under tub.

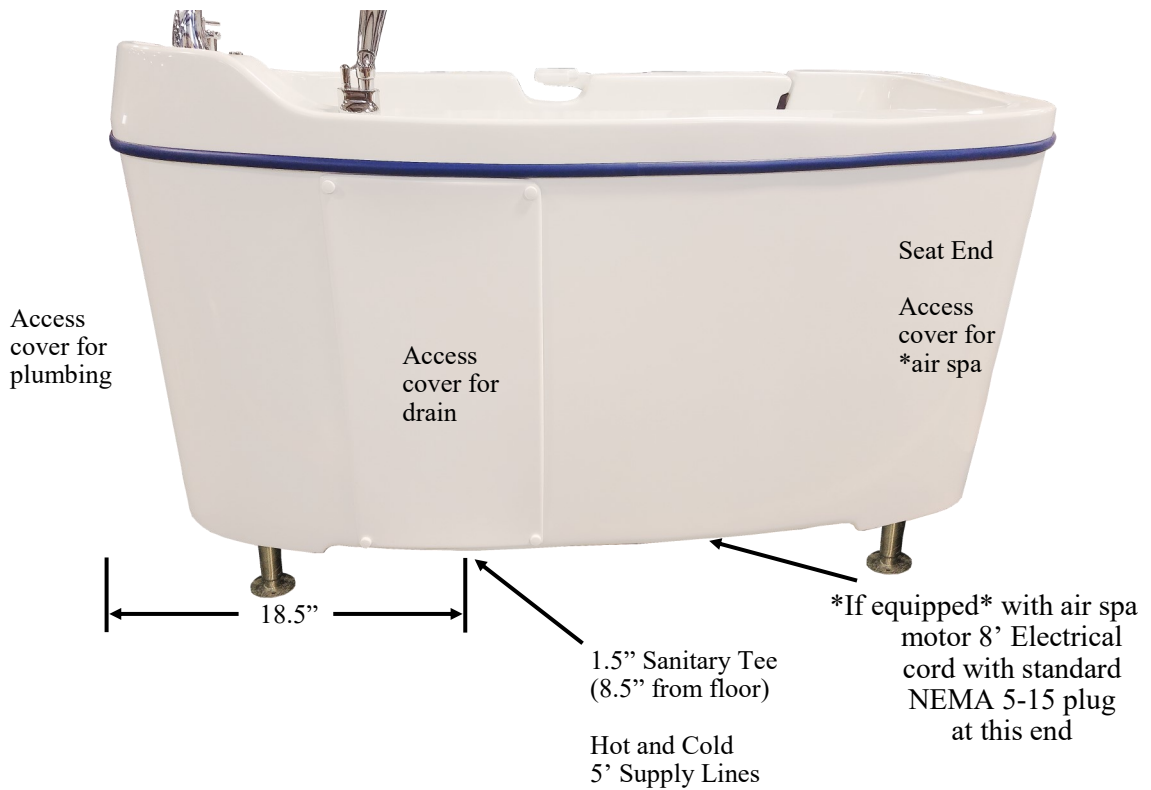

# Pre-Installation Drawings and Dimensions

## Suggested Plumbing and Electrical Layout

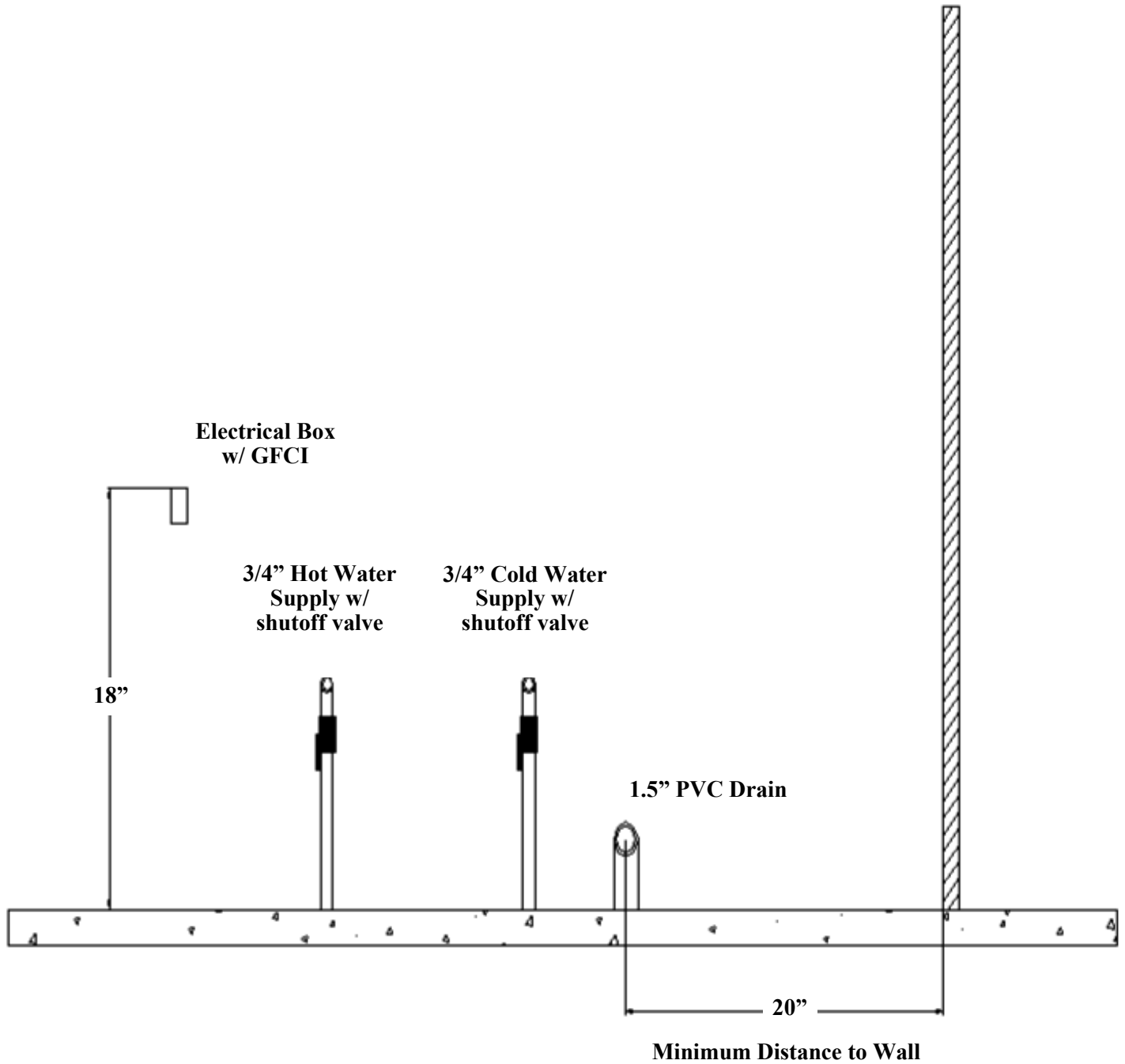

## **Installing the Tub**



**INSTALL TO PERMIT ACCESS FOR SERVICING.**



**All plumbing and electrical work must be performed by qualified individuals. Some state and local plumbing codes require the installation of a reduced pressure zone (RPZ) assembly on both hot and cold incoming supply lines to prevent the possibility of backflow contamination to the potable water supply. Always check local plumbing codes to determine if RPZ's are required for your tub installation. Some state and local agencies may also require that these devices be registered as well as tested on an annual basis. Refer to the local codes for final determination. RPZ's are not provided by the manufacturer and are the responsibility of the customer.**

The RK12E is designed to be installed as a freestanding unit. Several items of precaution should be taken during installation:

- **USE THIS PRODUCT ONLY FOR ITS INTENDED USE AS DESCRIBED IN THESE INSTRUCTIONS.**
- **DURING CONSTRUCTION, THE TUB'S SHELL IS VULNERABLE TO DAMAGE CAUSED BY FALLING OBJECTS, SUCH AS TOOLS AND CONSTRUCTION MATERIALS. DO NOT STAND IN THE TUB DURING INSTALLATION.**
- **NEVER STORE ANY CONSTRUCTION MATERIALS INSIDE THE TUB.**
- **PRINTED DIMENSIONS ARE FOR REFERENCE ONLY. MEASUREMENTS SHOULD BE TAKEN FROM THE ACTUAL TUB.**
- **THE TUB MUST BE WATER TESTED FOR LEAKS BEFORE THE TUB IS COMPLETELY ENCLOSED AND INSTALLED.**

**Step 1:** Determine final location and review framework for the tub. Rough-in plumbing and electrical hook-ups must meet building codes and regulations. When installing into an alcove, the tub should slide into the final location without binding. Please review section 2 for rough-in dimensions and allow for the spacing needed. Review the space requirements for lifting devices.

**Step 2:** Remove all packing material and cardboard packaging from tub. Set aside the accessory box which is located underneath or inside the tub. Remove the tub from the pallet. Make sure that the door is in the closed position during installation. This will allow for proper installation and help maintain the original shape of the tub.

## Installing the Tub (cont'd)

**Step 3:** Move the tub into the final location. Use a level across the back and side of the tub. If adjustment is needed, level the unit by turning the adjustable legs to raise or lower the tub. See picture below for more information. Open the door and make sure it does not swing open or close by itself. If the door opens or closes by itself, the unit is not level.

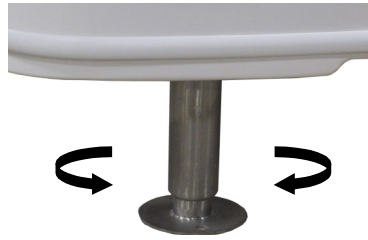

Turn counterclockwise    Turn clockwise  
to raise the tub

**Step 4:** Before hooking up the two 3/4 water lines, clean the main hot and cold water supply lines of debris prior to connection. Valves, shower wand, and accessories may become clogged and or damaged if the lines are not free of debris. Make sure that the screens are present and the hoses are not kinked or bent after hookup. The threaded connections are NOT “hose thread”, but rather “National Pipe Thread” (NPT). **The warranty does not cover damage caused by debris in the lines.**

**Step 5:** Connect the hot and cold water hoses, drain, and electrical connection. Double check all connections for proper fit and installation.

**NOTE: Make sure the unit is level prior to fastening to the floor.**

**Do not over tighten the floor connections. This could cause the unit to become un-level.**



**NOTE: If mobile lifts are used for transferring, verify that the lift base clears the plumbing and electrical connections. If possible damage could occur, you must install blocking or a stop to prevent contact between the lift base and the plumbing and electrical connections.**



**Step 6:** Make drain connection from sanitary tee on tub to the facility drain.

**Step 7:** If tub has air spa, plug the electrical cord into the GFCI outlet.

**Step 8:** Attach any accessories, including shower wand and disinfect hose assembly. The shower hose is concealed inside tub, and can be pulled out.

**Step 9:** Test tub for proper operation. Be sure to clean inside of tub prior to filling unit. Excess debris may damage the air spa jets or gel coat. Check the unit for any leaks.

**Step 10:** Remove any installation labels and directions. Clean tub with warm water and a non-abrasive cleaner.

**NOTE: The thorough inspection and startup of the tub is required before first use. It is the installer’s responsibility to check and tighten threaded and drain connections before using tub.**



# Using the Tub

## RK12E "Erie" Operating and Disinfecting Procedures

### Operating Procedures

- Transfer the resident into the tub and secure the resident with the lap and shoulder harness.
- Close door by pressing down on the "Door Lock" mechanism. Engage "Secondary Door Latch".
- Put drain stopper in place over the drain.
- Turn on water with "Tub Fill" valve.

**TEMPERATURES OVER 100° FARENHEIT OR 43° CELCIUS CAN SCALD.**

- To use the "Shower Wand" turn on the "Shower Diverter" valve and hold wand away from resident. Check the water temperature with you hand and the "Thermometer" before showing the resident. The "Shower Wand" may be used while filling the tub.
- Use *non-foaming* bathing solutions and/or bath oils, which are ideal for tubs with air spa systems.
- Pull the drain plug. Rinse and dry the resident while the tub is draining.
- Disengage "Secondary Door Latch" Open door by lifting up on the "Door Lock" mechanism.



### Air Spa System

To use the "Airspa" feature, push the "Airspa" button located on the control panel

- 1st press: Blower turns on at high speed.
- 2nd press: Blower changes to low speed.
- 3rd press: Blower turns off.
- The "Airspa" blower motor has a safety feature that automatically shuts it down after it runs continuously for 10 minutes. If a longer bathing experience is needed, press the on/off button and the motor will stay on for another 10 minutes.

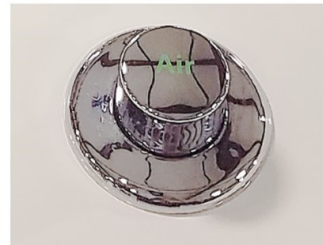

### Drying Cycle (Purge Cycle)

An automatic drying cycle will start **10 minutes** after the blower is turned off. Once the purge cycle begins, the air spa blower will run for one (1) continuous minute at maximum speed. The air spa blower **cannot** be turned off during the purge cycle.

### Disinfecting Procedure

- Use a spray bottle with the correct dilution ratio of water/disinfectant mixed to the manufacturing suggest mix.
- Allow the disinfectant solution to remain on the interior surface of the tub for the period of time recommended by the manufacturer.
- Use the scrub brush to scrub all surface area.
- Turn the shower wand diverter valve to on and rinse the interior surface of the tub until all disinfectant is removed from tub.
- Tub is now ready for next resident use.



# LIMITED WARRANTY

Rane® Safety and Accessibility products are warranted to be free from defects in materials and workmanship for a period of **five (5) years** for external finishes and composite shell, **three (3) years** for all moving and stationary parts, including but not limited to, valves, air spa blower, whirlpool pumps, actuators, door mechanisms, hinges, gauges, thermometers, and **Lifetime** for the door seal (provided preventative maintenance is performed as recommended.) *Shower and disinfectant hoses, handheld shower wands, disinfectant spray wands, and batteries are excluded from this warranty.*

**ALWAYS FOLLOW ALL SAFETY AND USE INSTRUCTIONS CONTAINED IN THE TUB AND LIFT USE MANUALS.**

## **COMMENCEMENT OF WARRANTY PERIOD**

Warranty commences on the date of shipment to Customer and/or Dealer.

## **REPAIR OR REPLACEMENT**

During the warranty period, Rane® will repair or replace any defective parts or portion thereof returned by Customer and/or Dealer if Rane® determines was **defective due to faulty materials or workmanship**. The Customer and/or Dealer must obtain and **Return Goods Authorization (RGA)** number from Rane®. *The Customer and/or Dealer will pay all related labor and return costs incurred in the replacement, installation, or repair of the defective parts or portion thereof to Rane® except that in year one Rane® will pay for shipping.* Rane® retains the exclusive right to repair or replace the defective products or parts or portions thereof at its sole discretion. In the event that it is determined that the cost of warranty repairs and/or parts is excessive, Rane® may require the Customer and/or Dealer to provide a written report and pictures of the defect for review. In the event that replacement parts are sent by Rane® to the Customer and/or Dealer before the defective parts have been received and reviewed by Rane®, the Customer and/or Dealer will be invoiced for the replacement parts and shipping costs. Once the defective parts have been received by Rane®, and deemed to be defective due to faulty materials or workmanship, a credit or refund will be issued to the Customer and/or Dealer. In the event Rane® determines the repairs and/or parts were not covered by warranty due to misuse or other reasons, customer shall pay for the charges for all repairs including parts, freight, and labor warranty of parts subject to “normal wear and tear” (i.e. cushions, pads, lap and shoulder belts, shower wands, and hoses) are not covered under this warranty except as it applies to the defects in materials and workmanship.

## **EXCLUSIONS**

This limited warranty applies only to the Rane® tubs sold and used in Canada or the United States, and does not apply to equipment that has been damaged or rendered defective as a result of:

- a) Acts of God, accident, misuse, neglect, or abuse
- b) Use of parts not manufactured or sold by Rane®
- c) Modification without the written permission of Rane®
- d) Service by anyone other than Rane® or a Rane® Authorized Agent
- e) Transit, neglect, misuse, power surge, or operating environment
- f) **Failure to inspect tub upon delivery for shipping damage will void any liability of Rane® since shipping damage that is not indicated on the accepted shipping documents as this excuses shipper from any liability**

12/2016 MGM



## LIMITED WARRANTY

- g) Failure to provide regular maintenance, service, or inspections
- h) Failure to operate in accordance with manufacturer's guidelines or any other improper operation or maintenance, or
- i) Any other cause not directly and primarily caused by defective material, workmanship, or design including abnormal water conditions including without limitation excessive hardness or acidity or temperatures above prescribed amounts.

Service performed as a result of these conditions will be subject to charges for labor, transportation and shipping, and parts.

Rane® will not be responsible for any water damage to structures or property for any reason including but not limited to manufacturer defects or improper installation. Rane® will assume no responsibility for the loss of the system, inconvenience due to loss, damage to real or personal property or any other consequential damage. Rane® will not be liable for any labor or incidental expenses or material charges in connection with removal or replacement of the walk-in bathtub or any part or parts of the System.

### **SOLE WARRANTY**

These express warranties shall be the sole and exclusive warranties of Rane®, with respect to the tubs ("goods") and services provided in connection with the goods and shall be in lieu of, and exclude, all other express or implied warranties of any kind whatsoever, including to the maximum extent permitted by law warranties of merchantability and fitness for a particular purpose. In no event shall Rane®, its subsidiaries, affiliates, agents, or employees be liable for any incidental indirect, special, or consequential damages in connection with or arising out of the warranties contained herein or the sale or furnishing of any goods, services, or other items hereunder, or any third party's ownership, maintenance or use of any goods, services or other items furnished hereunder including, but not limited to, lost profits or revenues, loss of use of the goods or any associated products, damage to associated products, costs of capital, costs of substitute goods or products, or claims of customers for such damages. In no event shall Rane®, its subsidiaries, affiliates, agents or employees be liable for the negligence or other intentional misconduct of any third-party nor shall Rane® be liable for its gross negligence, or intentional misconduct. The sole remedy for any liability of Rane® of any kind, including, but not limited to, gross negligence, fraud, or intentional misconduct, with respect to any goods, services or other item or service to which these warranties are applicable or otherwise, shall be limited to the repair or replacement of any goods determined by Rane® to be defective hereunder, and in no event shall Rane® be liable for damages in any amount exceeding Rane's® replacement cost of the claimed defective product. Rane® will not be responsible for meeting any federal, state, local, or municipal code or specification (whether statutory, regulatory, or contractual), including special building or construction codes, unless Buyer so specifies in writing at the time of order and an authorized employee of Rane® agrees in writing.

The parties knowingly and willingly waive any right they have under applicable law to a trial by jury in any dispute arising out of or in any way related to these warranties of the issues raised by that dispute.

The Laws of the State of Tennessee shall govern the validity and construction of these warranties and all rights and obligations of, and disputes between or among, the parties arising out of or related to these warranties, whether in contract, tort or otherwise, without regard to the principles of conflict of Laws of the State of Tennessee. The parties submit to the jurisdiction of all State and Federal Courts sitting in the State of Tennessee, and all actions and proceedings arising out of or relating to these warranties shall be heard and determined in a State or Federal Court in Tennessee.

# Maintenance and Adjustments

## Door Adjustments

If door adjustment is needed, read the instructions below for proper adjustment.

If the door is leaking, it may need adjustment. To adjust the door tension:

1. To open the door, make sure the secondary latch is disengaged. Pull upward on the door handle and swing door outwards. Next, push handle down so aluminum pivot lock is exposed.
2. Use a 5/64 Allen Wrench and turn the set screw at the end of the aluminum pivot lock counterclockwise one complete revolution to raise the delrin latching knuckle upward.
3. Re-test door latching operation and check for any leaks.
4. If no leaks, door is ready for regular use. If door still leaks, repeat steps 2 and 3.

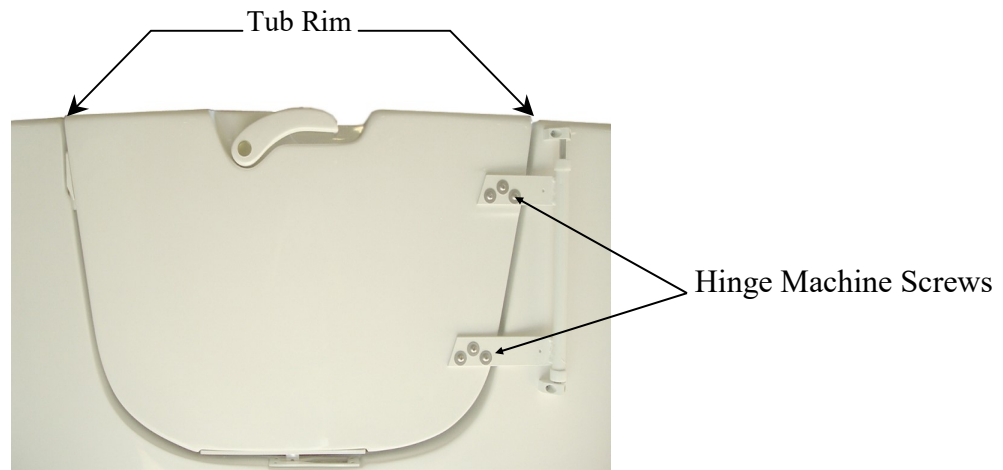
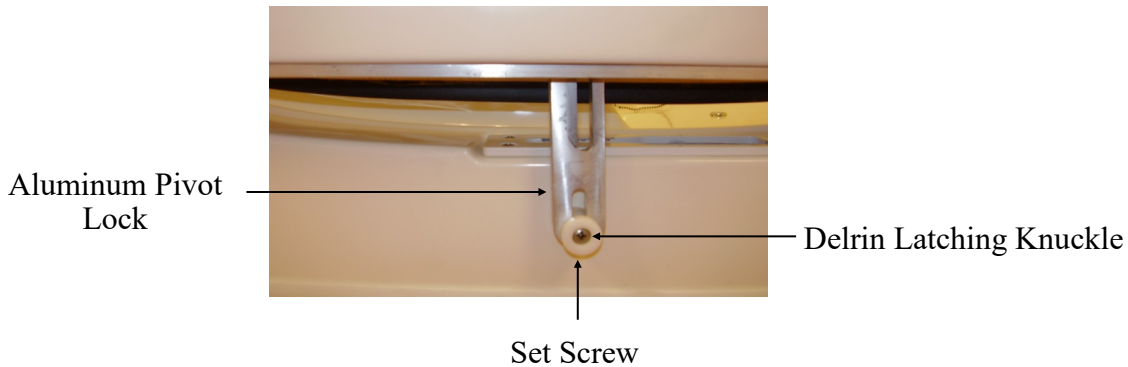

If door is out of alignment in the tub rim and seal area, it may need to be re-aligned.

1. To open the door, make sure the secondary latch is disengaged. Pull upward on the door handle and swing door outwards.
2. Behind hinge, there are two Phillips head screws that are holding the hinge cover, remove these two screws and remove the hinge cover. After hinge cover is removed close door and lock into place.
3. Loosen the 6 door hinge machine screws with a #3 Phillips screw driver.
4. Adjust door by applying pressure to the middle of the door. While pressure is on middle of door pay particular attention to height of left and right sides of door in relationship to top rim of tub.
5. Re-tighten screws and verify door operation.

## Maintenance and Adjustments (cont'd)

### Contents of Door Seal Kit

- Rubber Door Seal
- Two (2) Black Push Pins
- Sandpaper
- Glue Brush
- Contact Cement
- Instructions

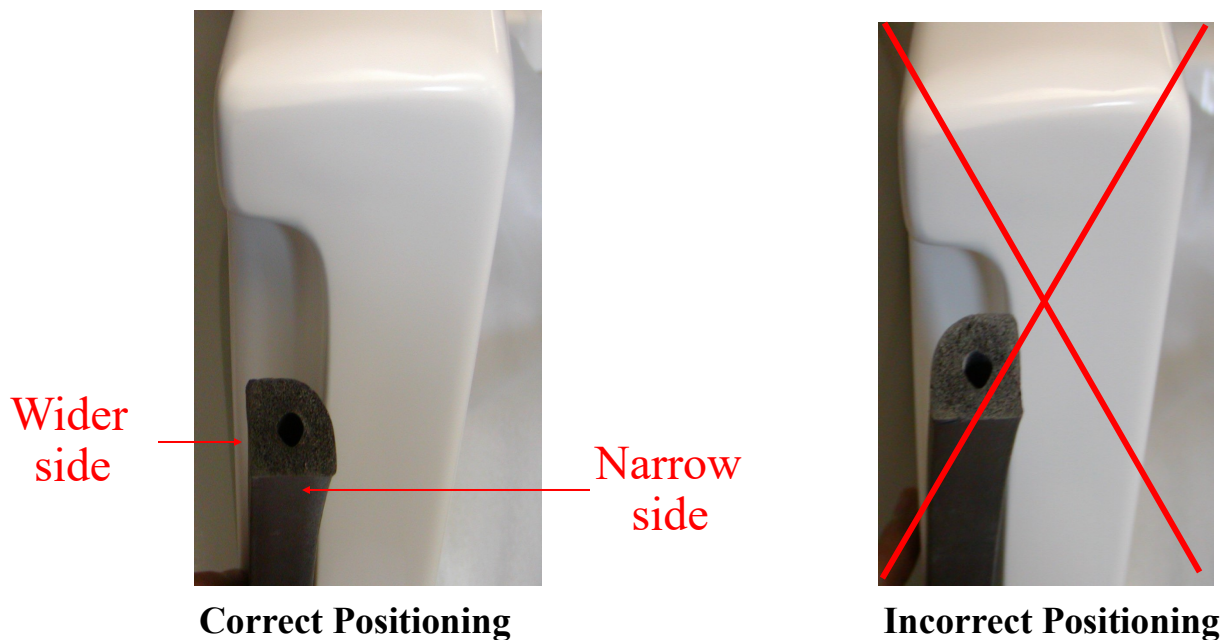

### Instructions

1. Remove existing seal, 2 push pins, old glue and seal remnants. Make sure door is free of glue and debris. Lightly sand the surface of the door and seal.

**NOTE: LIGHTLY SAND THE SURFACE OF THE SEAL! DO NOT BREAK THE SURFACE OR SKIN OF THE SEAL. THIS WILL CAUSE THE SEAL TO FAIL.**



2. Using glue brush, apply an even coat of glue to both the seal and surface on the door.
3. Allow the glue on both surfaces to skin over, approximately five (5) minutes.
4. Beginning at one end of the seal, carefully place the seal into seal area of door taking care to make good contact between the door and seal. Be sure that the seal is positioned as shown above.
5. Use masking tape as necessary to help hold seal in place.
6. When entire seal is in place, taper ends as needed for proper fit and insert push pins at both ends of doors.
7. Use lacquer thinner on a towel to clean excess glue off the door surface.
8. Allow the glue to set for at least two (2) hours before the first use.

**NOTE: THE USE OF PETROLEUM BASED CLEANERS OR LUBRICANTS WILL CAUSE THE RUBBER DOOR SEAL TO FAIL. TO CLEAN THE SEAL, USE MILD WARM SOAPY WATER OR PRODUCTS THAT ARE DESIGNED SPECIFICALLY FOR RUBBER PRODUCTS.**



# Maintenance and Adjustments (cont'd)

## Routine Maintenance

Contact your local Authorized Dealer / Distributor for periodic updates to this schedule.

Model # \_\_\_\_\_

Serial # \_\_\_\_\_

Check List	Monthly	3 Months	6 Months	Yearly
Inspect and Test GFCI	<b>X</b>			
Check Disinfectant System		<b>X</b>		
Check Hand-Held Shower Wand and Hose		<b>X</b>		
Check Tub-Fill and Shower Valve Operation		<b>X</b>		
Check Hoses and Connections			<b>X</b>	
Check Thermometer for Accuracy			<b>X</b>	
Check Thermostatic Mixing Valve			<b>X</b>	
Check Maximum Water Temperature			<b>X</b>	
Clean Hot and Cold Supply Hose Screens			<b>X</b>	
Check that all Access Panels are secure				<b>X</b>
Check Air Spa Functions and Controls (if applicable)			<b>X</b>	
Replace Air Spa Jet Inserts (if applicable)				<b>X</b>
Check and Clean Door Seal (if applicable)	<b>X</b>			
Check Door Mechanism (if applicable)	<b>X</b>			
Check Door Alignment (if applicable)			<b>X</b>	
Check Hinge Screws (if applicable)			<b>X</b>	
Check Raise / Lower Buttons (RR7-II & RS8)			<b>X</b>	
Inspect and Lubricate Actuator (RR7-II & RS8)			<b>X</b>	
Check Auto-Fill Buttons / Operation (RR7-II & RS8)			<b>X</b>	

# Troubleshooting

<b>Problem / Issue</b>	<b>Check</b>	<b>Action / Solution</b>
Door is Leaking	Check door seal	Re-attach door seal if loose or replace if damaged (see Section 6.2)
	Check door positioning	Align door (see Section 6.1)
	Check door latching knuckle	Adjust door tension (see Section 6.1)
Water too hot or too cold	Check hose washer / screen in end of supply hoses	Remove and check for debris or build-up, clean or replace if needed
	Check hot and cold supply lines for kink(s) or damage	Remove kink(s) or replace if needed
	Check if hot and cold connections are properly installed	Reverse connections if backwards
	Check if water supply dynamic pressures are within 10% of each other	Consult with a local Plumber
	Check thermostatic mixing valve for proper temperature calibration	Calibrate (see Section 9.2)
	Check thermostatic mixing valve cartridge	Remove and check for debris or build-up (see Section 9.3)
Valve package not working properly (ie. tub-fill and shower valves)	Check knobs	see Section 10
	Check valve stems	Check if damaged or properly tightened (see Section 10)
Door swings open or closes by itself	Check if tub is level	Level the tub (see Section 3.1)
	Check door positioning	Align door (see Section 6.1)
Door will not open or close properly	Check door seal for soap scum or mildew build-up	Clean with mild soapy water and let dry, then put baby powder on the seal.
	Check door positioning	Align door (see Section 6.1)
	Check door latching knuckle	Adjust door tension (see Section 6.1)
Air Spa not working properly (if equipped)	Check if plugged into outlet and/or damage to the electrical cord	Plug-in and/or replace the electrical cord if needed
	Check if GFCI outlet is working properly	Reset GFCI outlet / breaker
	Check gray hose for either kink(s) or has come off the air spa motor or manifold	Remove kink(s) or re-attach gray hose to air spa motor or manifold by tightening the hose clamps
	Check Air Spa Jets (12 total)	Clean or replace spring loaded check valve (see Section 11.1)
	Check for User error	see Section 4 (Using the Tub)
Disinfectant System not working properly	Check clear tube that goes into the disinfectant bottle	Un-clog the clear tube and/or mesh filter on the end of the tube
	Check disinfectant knob	Tighten if needed (see Section 12)
	Check DEMA Valve	Remove and clean (See section 12)

## Door Replacement Parts List

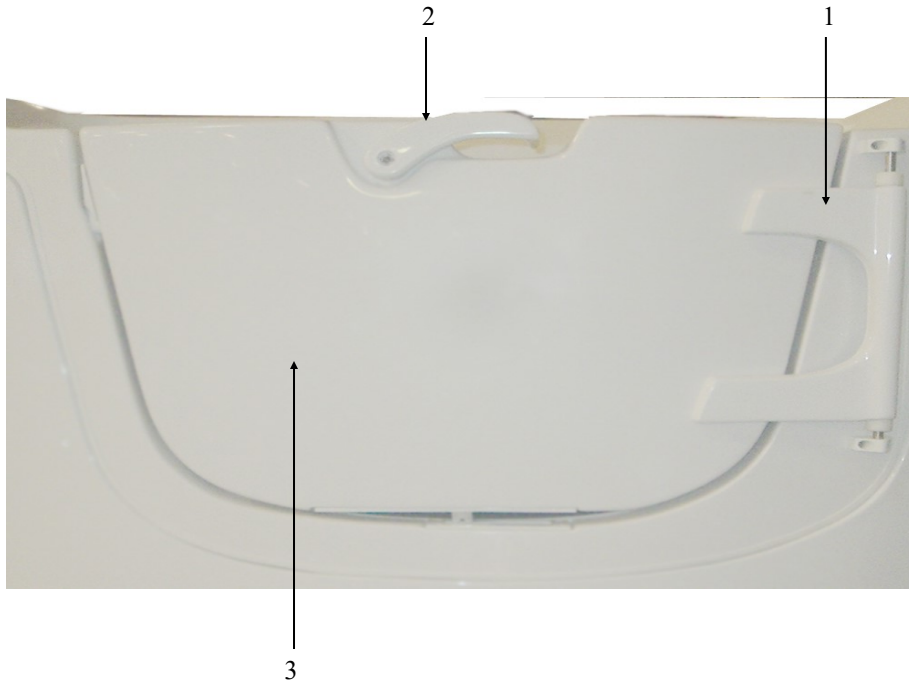

<u>#</u>	<u>Part #</u>	<u>Description</u>
1	HC	Hinge Cover, acrylic * <i>right hinge only</i>
2	3416+H	Door Handle, RH w/ Aluminum Pin (includes hardware)
3	OSDR	Right Hinge Door, Complete

\* *The complete door assembly includes door, door mechanism, and door handle*

## Door Replacement Parts List (cont'd)

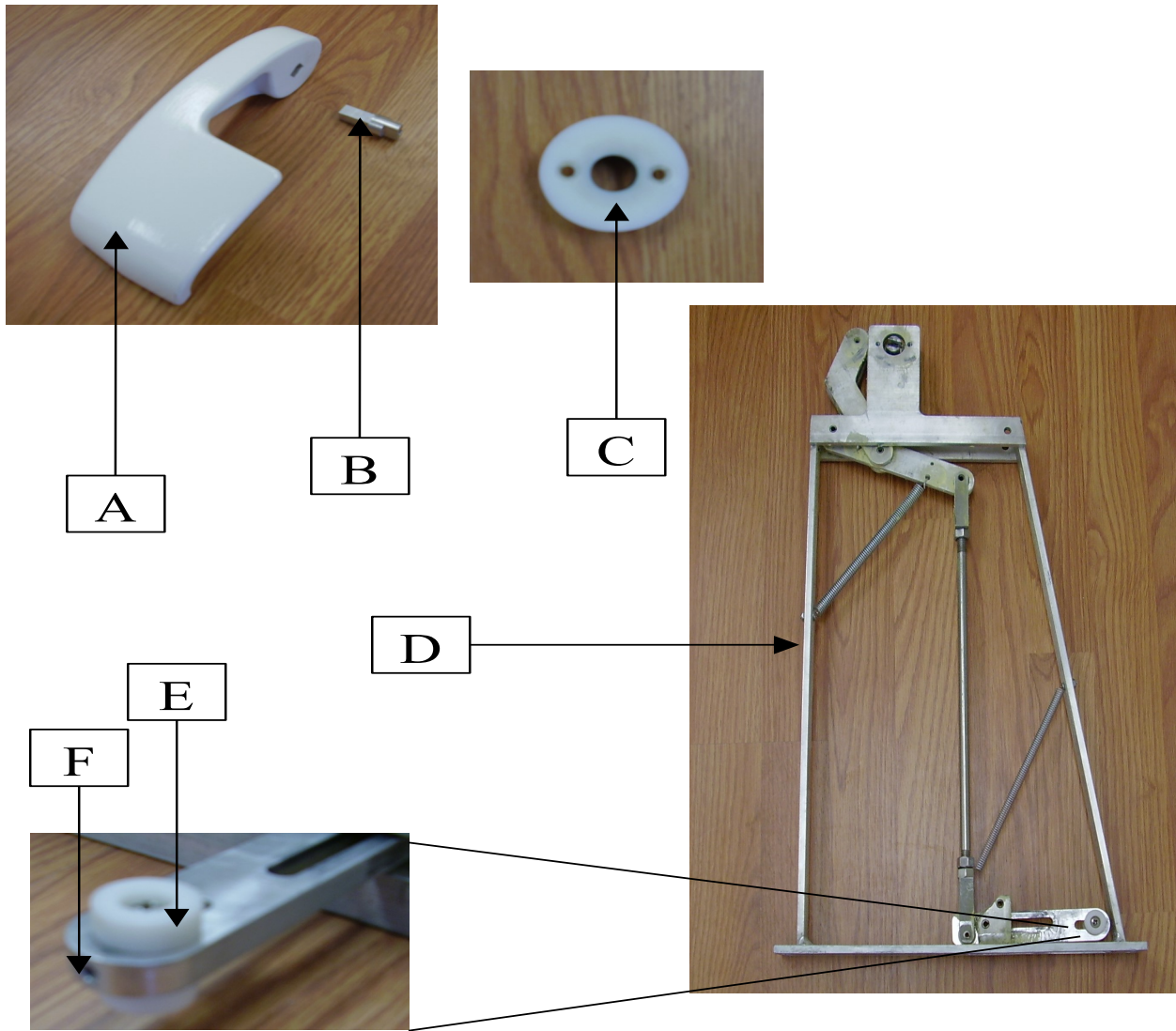

<u>#</u>	<u>Part #</u>	<u>Description</u>
A/B	3416+H	Door Handle, RH w/ Aluminum Pin (includes hardware)
C	3245	Outside Delrin Bushing
D	DOOR MECH	Door Mechanism * <i>right hinge only</i>
E	3215	Delrin Knuckle, Door Mechanism (incl. 10-24 x 7/8" pan head screw)
F	1040	Set Screw, 8-32 x 3/8" (Delrin Slide)

# Door Replacement Parts List (cont'd)

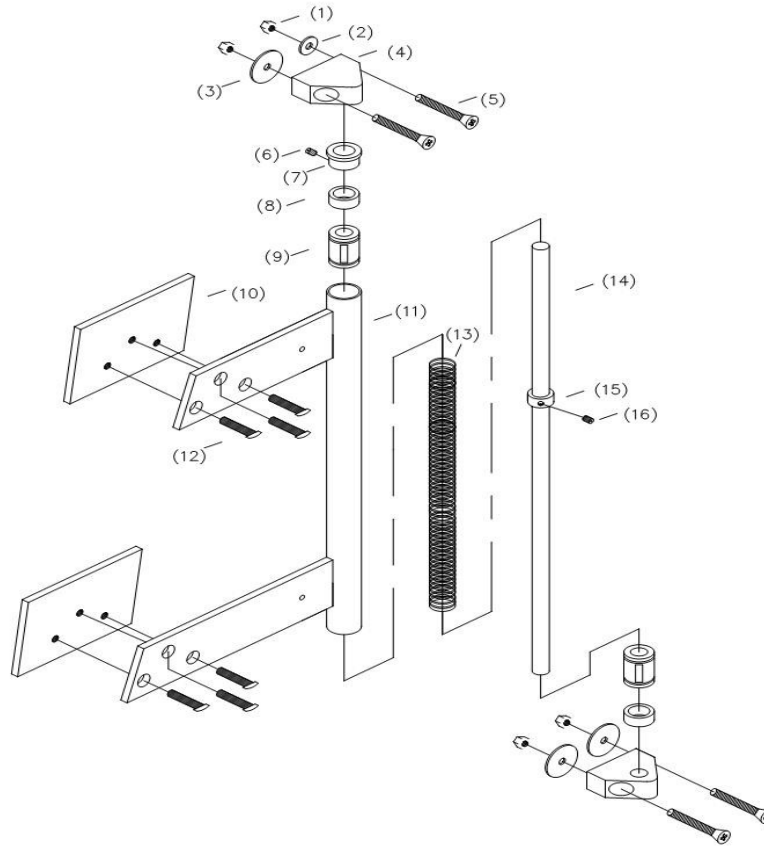

<u>#</u>	<u>Part #</u>	<u>Description</u>
4	3381	Hinge Rod Retainer / Blocks, Each
	3336+H	Complete Hinge Assembly, Right Hinge

# Air Spa System

## HOW TO REPLACE AN AIR SPA JET ASSEMBLY?

**TOOLS NEEDED: SMALL FLAT TIP SCREWDRIVER AND SMALL NEEDLE NOSE PLIERS**

**Step 1:** Turn on air spa motor for 30 seconds to blow out any water in the assembly.

**Step 2:** Place the drain plug over drain hole or close cable drain to avoid any parts falling into the tub drain.



**Step 3:** Using a small flat tip screwdriver, insert tip into one of the 6 small openings in the jet cover cap and gently pop off. **Be careful not to damage gelcoat or nylon assembly.** Using small needle nose pliers, remove the "y" piece (see Fig. 1) to expose the internal parts of the jet assembly and remove the old brass insert and spring. **Do not lose or throw out the "y" piece,** set aside.

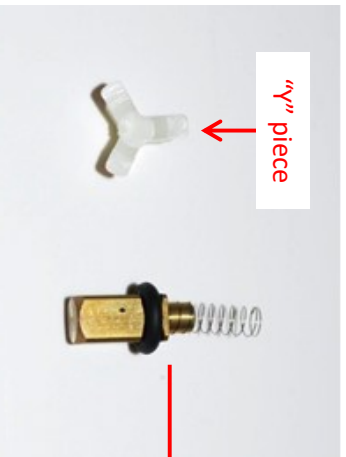
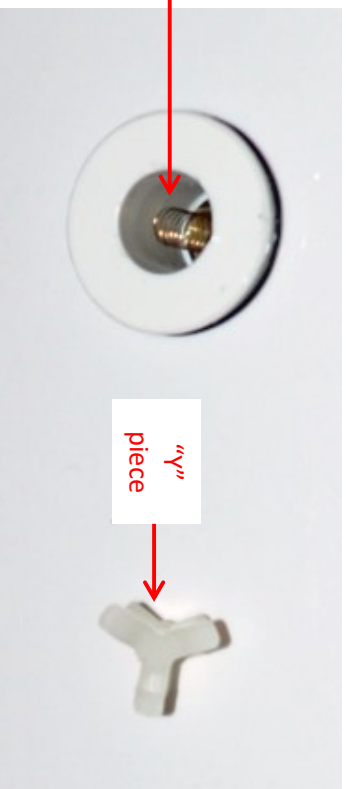

Fig. 1



**Step 5:** **Make sure the jet assembly is free of debris, mildew, or any buildup before inserting new brass insert and spring.** Clean with cotton swab if needed. Insert the new brass insert and spring into the existing jet assembly. Make sure the spring is installed directly in the center of the jet assembly.



**Step 6:** Insert the "y" piece directly centered on the spring. Push down on the "y" piece till it snaps into place. Spring must be centered to work properly (see above picture). Install jet cover cap. Press until you hear a snap noise indicating it's in the correct position.