



Panacea® 3500 BED

Owner's Manual

Please keep and refer to this Owner's Manual.

Thank you for purchasing a Panacea® 3500 Bed from Direct Supply Equipment & Furnishings®. Please read this entire guide carefully and keep it for future reference. This guide will provide you with instructions, warnings, warranty information and other important information about your Panacea bed. Share this information with your housekeeping, nursing and maintenance staff to help ensure the bed is cared for properly.

Introduction

Table of Contents

Warnings	3 - 6	Accessories & Options	13 - 15
Specifications	7	Optional Battery Backup.....	13
Environmental Conditions	7	Optional Footboard Control.....	13
Electrical Specifications	7	Safety Lock	13
Technical Specifications.....	7	Free-standing Trapeze	13
Locating Your Serial Number.....	7	Overbed Trapeze	13
Application Environments	7	Panacea Advanced Staff Control Kit.....	14-15
Directions for Use	8 - 12	Servicing	16 - 20
Unpacking	8	Troubleshooting	16 - 17
Assembly	8	Steps for Isolating Electrical Problems.....	16
Wall Bumper	8	Control Box Socket Identification	18
Headboards & Footboards	9	Replacement of Power Cord	18
Installing the End Mattress Retainers	10	Bed Diagram	19 - 20
Locating & Connecting Handset.....	11	Cleaning	21
Bed Positioning.....	11	Cleaning Method	21
Deck Expansion	11	Cleaning Instructions	21
Resetting Bed Positioning	11	Periodic Inspection	21
Bed Transport	12	Limited Warranty	22
		Customer Service	23

Definitions & Symbols

NOTE: Indicates a tip.

CAUTION: Indicates correct operating or maintenance procedures in order to prevent damage to or destruction of the equipment or other property.

WARNING: Calls attention to a potential danger that requires correct procedures or practices in order to prevent personal injury.

DEVICE: Panacea® 3500 Bed.

YOU and YOUR: The facility, community or other entity that has purchased the device.

WE, US and OUR: Direct Supply Manufacturing, Inc.



Attention. Read the instructions.



Electrified



Do NOT Put Batteries in Trash



Earth Ground



Indoor Use Only

Warnings

Warnings

Read and follow all directions and warnings before using this device. Do not operate this device without first reading and understanding this user manual. Damage or injury may result from improper use of this device. The information contained in this document is subject to change without notice.

⚠ WARNINGS

1. Failure to comply with all directions and warnings may result in injury or death; use only as directed.
2. This device is not suitable for all individuals. Other devices may be required.
3. Inspect the device for damage before each use, and do not use it if it appears to be damaged or not functioning properly.
4. Never alter the device in any way.
5. This device is designed for indoor use only within close proximity to skilled caregivers.
6. This device is not designed to operate with residents and accessories weighing more than 600 lbs. combined.

⚠ WARNING: The correct bed height when unattended is based on the resident's knee-to-floor height, mobility and cognitive level. For residents with good mobility and cognition, the top of mattress should be at a height so the resident's feet are flat on the floor and the angle between the thighs and calves is 90 degrees. Bed height and the resident's abilities must be evaluated by a medical professional.

⚠ WARNING: The mattress should be a hospital-type mattress to allow for proper bed articulation. The mattress must be properly sized to meet entrapment zone dimensional guidelines published by the FDA.

⚠ WARNING: If the resident's physical or mental state may lead to entrapment, the sleep deck should be left in the flat position when unattended.

⚠ WARNING: DO NOT use near explosive gases.

⚠ WARNING: Possible fire hazard if used in conjunction with a nasal mask in ½ bed tent of oxygen-administering equipment. If O₂ tent is being used, it should not fall below mattress deck. The pendant should not be placed in an oxygen-enriched environment such as an O₂ tent.

- Possible fire hazard when used with oxygen-administering equipment other than nasal or masked type
- When using nasal or masked type administering equipment, oxygen or air tubing **MUST** be routed and secured properly to ensure tubing does not become entangled, kinked or severed during normal operation of the bed.

⚠ WARNING: This device includes assist rails. Some states may prohibit assist rails or consider assist rails to be resident restraints. Always assess whether restraints are necessary on a case-by-case basis and document the need for any resident restraint. Contact your state surveyor for further guidance regarding assist rails and restraints.

Warnings *(cont.)*

⚠ WARNING: To reduce the risk of electrocution:

1. Do not operate near water.
2. Do not allow any part of this device to be placed into or dropped into water or other liquid.
3. Do not reach for a device part that has fallen into water. Unplug immediately.
4. Do not remove control unit cover.
5. Always clean this device in a manner consistent with the cleaning instructions in this manual (see Care and Maintenance section).

⚠ WARNING: To reduce the risk of burns, fire or injury to persons:

1. Use this device only for its intended use, as described in the operating instructions.
2. Never operate this device if it has a damaged cord or plug, if it is not working properly, if it has been dropped or damaged, or if it has been dropped into water. Return the unit for examination and repair.
3. Keep the cord away from heated surfaces.
4. Never drop or insert any object into any opening or hose.
5. Do not use outdoors.

⚠ WARNING: This bed may require other equipment which may include, but is not limited to:

1. Bedrails for repositioning and fall prevention
2. Resident monitoring devices for elopement prevention
3. Other devices as specified by the caregiver

⚠ WARNING

This device is only a tool as part of an overall care plan. Failure to comply with all instructions, warnings and precautions, or using the device for a purpose other than the recommended use, could result in bodily injury or death. This device is not designed to replace good caregiving practices including, but not limited to:

- Direct resident supervision
- Adequate care plans and training for staff personnel for entrapment and fall prevention
- Inspection and testing before use

No part or component of a Panacea Bed should be used with non-Panacea bed parts or components.

Possible entrapment hazard may occur if you do not use an appropriate mattress. Resident entrapment may lead to injury or death. You should consult with a healthcare professional to determine the appropriate mattress and accessories for the specific resident.

⚠ WARNING: Any cords or tubing used on or with this bed **MUST** be routed and secured properly to ensure they do not become entangled, kinked or severed during normal operation of the bed.

⚠ WARNING: Do not plug anything into housing components of bed (pendants or actuators) while power cord is plugged into the wall outlet.

⚠ WARNINGS – General

- When using liquids in or around the bed, caution should be taken to ensure liquids of any kind are not spilled. If a liquid is spilled in or around the bed, **UNPLUG** the bed immediately. Clean up spill and allow bed and area around bed to dry thoroughly before using the electric controls again.

⚠ WARNINGS – General

- After installation and before use, make sure all attaching hardware is securely tightened.
- Pendant cord must be routed and secured properly to ensure cord does not become entangled and damaged during normal operation of the bed.
- Keep all moving parts free from obstruction (e.g., blankets/sheets, heating blankets/pads, tubing, wiring, etc., which may get tangled around the bed, assist rails or legs during operation of the bed).
- Bed is equipped with locking casters. Casters should be locked at all times, except when moving the bed or when operating subacute care features.
- The assist rails are NOT intended for and may NOT be used as a restraint. If necessary, a physician or healthcare professional should be consulted for other means of safe restraint.
- When using assist rails, if excessive side pressure is exerted on them, they can be deformed or broken. Do not use assist rails as handles to move the bed .
- Never permit more than one person in/on the bed at any time.
- Body weight should be evenly distributed over the surface of the bed. The bed weight capacity is 600 lbs. This is the total weight of the resident, mattress, bedding, headboards and footboards, assist rails, and any other accessories. Exceeding weight limit may cause bed to fail.
- Do not allow resident to lie, sit or lean in such a way that the entire body weight is placed only on raised head or foot sections of the bed. This includes while assisting the resident in repositioning or transferring in or out of bed.
- The bed is provided with an additional safety feature of a protective earth ground to help protect against possible shock hazard. The electrical cord should only be plugged into a grounded 110/120V outlet. DO NOT ALTER THE PROVIDED PLUG. Do not under any circumstances cut or remove the grounding prong. If the plug does not fit the existing outlet, a licensed electrician should install a correct outlet. Never operate the bed if it has a damaged cord or plug.
- Unplug the power cord when performing any maintenance on the bed.
- DO NOT open any actuators, control boxes or pendants. Service is only to be performed by authorized service personnel. If unauthorized service is performed on any components, the warranty is void.
- NEVER allow anyone under the bed at any time.
- Supervision is required when this device is operated by or near children or people with disabilities.
- Ensure the individual using this bed is properly positioned, particularly when the bed is being operated or moved. Do not let any body parts protrude over the side or between parts, especially when the bed is being operated or moved.
- Possible injury may occur if bed is not kept in the lowest position, except when care is being provided. Bed should be at lowest suitable height for entry and exit.
- Possible injury or death may occur due to potential for pendant cord to entangle resident. Residents with decreased mental acuity should NOT have access to pendant.
- Possible injury or death may occur if the bed is pushed over abrupt thresholds while occupied. This bed was not designed to transport residents. Do not roll the bed over any power or pendant controls.
- The Safety Lock provides the resident with a stable and secure bed, providing easy access in and out of the bed. Check that the Safety Lock is engaged and the bed is solidly in place before leaving the bed unattended or before attempting resident transfers into or out of the bed.
- The Safety Lock is not intended for use on a sloping floor or building access ramp. Use of the Safety Lock on a sloping floor or building access ramp could result in injury or death.
- The Safety Lock should be locked at all times, except when the bed is being moved.

⚠ CAUTION: This bed frame complies with EMC requirements of IEC 60601-1-1. Radio transmitting equipment, cell phones or similar electronic devices, used in proximity of the bed, may affect the bed's performance.

Warnings *(cont.)*

⚠ WARNING: The device should ONLY be used to transport residents in the event of an emergency.

⚠ WARNING: Reducing the Risk of Entrapment

The Hospital Bed Safety Workgroup (HBSW), in partnership with the FDA, has recognized potential entrapment zones in hospital bed systems and has developed dimensional guidance to reduce the risk of entrapment. The FDA considers the term “hospital bed system” to encompass the bed frame and its components, including the mattress, bed assist rails, headboards and footboards, and any accessories to the bed.

The entrapment zones involve the relationship of components controlled by the healthcare facility or individual user. Compliance to the dimensional guidelines for reducing the risk of entrapment is primarily the responsibility of the healthcare facility or the individual user. Anyone having any involvement with hospital bed systems should review and understand the FDA guidelines. These guidelines, titled “Hospital Bed System Dimensional and Assessment Guidance to Reduce Entrapment – Guidance for Industry and FDA Staff,” are available at the FDA website.

⚠ WARNING: Steps to Reduce the Risk of Fires

- Inspect all cords for damage, including the power cord and hand pendant.
- Connect the power cord directly into a wall-mounted outlet in good working order, with no cracks or chips. The plug should fit tightly into the outlet. The ground pin should be intact and secure.
- Do not use power strips, extension cords or multiple-outlet strips. Connect directly to a grounded, wall-mounted outlet.
- Do not cover any power cord with rugs, linens, cloths or other items that may cause heat to build up. Heat may build up or the cord may be damaged.
- Check surrounding equipment for signs of excessive heat or physical damage.
- Inspect the floor beneath the bed for buildup of dust and lint. Ask housekeeping to clean if necessary.
- Inspect the resident’s bed controls, looking for signs of damage where liquids could leak in.
- Test the bed and its controls, including resident lockout features, to ensure the bed can move freely in both directions without damaging any cords.
- Keep linens and clothes away from power sources.
- Tell maintenance staff about any unusual sounds, burning odors or unusual movement of bed.
- If you suspect overheating, follow your facility’s policy for fire safety and move the resident to a safe area if necessary.

⚠ WARNING (When using the optional Panacea® Advanced Staff Control Kit accessory): Height and angle readouts are for comfort positioning only. Do not use angle readouts for monitoring head deck angle for use with feeding tubes. Do not use height and angle readouts for setting clinical positioning or for taking measurements. Readouts are intended only to aid residents and caregivers in setting the bed for optimal comfort and resident preference.

⚠ WARNING (When using the optional Panacea® Advanced Staff Control Kit accessory): Height and angle readouts may change slightly over time due to actuator wear, metal fatigue or other conditions. Do not use the height or angle functionality on the advanced staff control for monitoring clinical positioning, including setting the head deck angle for use with feeding tubes.

Specifications

Environmental Conditions

Indoor use only
Ambient temperature range of 10° to 40°C
Relative humidity range of 30% to 75%
Atmospheric pressure range of 20.6" to 31.3" of Hg.
Control Box and Actuators – IP54 Protected against dust and splashing water
Handsets – IP66 Protected against dust and low-pressure jets of water

Electrical Specifications

Power: 110/120 V.A.C.
Frequency: 60 Hz
Current Rating: 2.5 Amps
Duty Cycle: 10% Max. (2 min. on/18 min. off)

Technical Specifications

Overall Length*	85.5" (expandable to 89.5")
Overall Width**	41.5" (expandable to 47.5")
Sleep Deck Length	80" (expandable to 84")
Sleep Deck Width	35.5" (expandable to 37.5" or 40.5") *****
Deck Height Range	7" - 30"
Weight of Bed***	RIL – 230 lbs. MAH – 240 lbs.
Safe Working Load****	600 lbs.
Maximum Back Angle	58 degrees
Maximum Hip-to-Knee Angle	48 degrees
Trendelenburg Capable	Yes
Reverse Trendelenburg Capable	Yes
Cardiac Chair Capable	Yes

* With headboards and footboards in the shortest assembled position

** With assist rails

*** Without mattress or assist rails



**** This includes the weight of the resident and all other accessories including, but not limited to, mattresses, headboards and footboards, assist rails, etc.

***** 35.5" fits most 35" or 36" mattresses; 37.5" fits most 39" mattresses; 40.5" fits most 42" mattresses. Always check your bed/mattress combination for fit, function, support and entrapment compliance before use with residents.

Locating Your Serial Number

The serial number label is located at the foot end of the bed, on the bed frame under the mattress support deck.

	Distributed by: Direct Supply Manufacturing, Inc. 6699 N Industrial Road Milwaukee, WI 53223	Serial No. 0123456
		Date of MFG. 01/01/11
		Part No. 10700XXBEI
		E212295
		Complies with:
		IEC 60601-1 3rd Edition
		IEC 60601-2-52
		CAN/CSA C22.2 No. 60601-1-08
		U.S. Patent No. Pending

		= 600 lbs.
120 VAC - 2.5 Amps - 60 Hz		
Duty Cycle: 2 min. on / 18 min. off		

Application Environments

This bed is intended for:

- Application Environment 3 – Long Term Care in a medical area where medical supervision is required and monitoring is provided, if necessary, and ME EQUIPMENT used in medical procedures may be provided to help maintain or improve the condition of the RESIDENT.

This bed is **NOT** intended for application environments 1, 2, 4 or 5.

Directions for Use

Unpacking

△ NOTE: Unpack the bed in an area with sufficient room to work. Do not allow residents near the bed until it has been completely set up and the work area has been cleared of all debris.

1. Inspect the bed for shipping damage. Bed should be received on a pallet covered by a box. If the bed is damaged, **DO NOT USE BED** and immediately contact Direct Supply Equipment & Furnishings® for further instruction.
2. Verify the proper bed model and size was shipped. If you feel there was a mistake, **DO NOT USE BED** and immediately contact Direct Supply Equipment & Furnishings

Installation

Tools Required:

- Rubber mallet or other non-marring mallet
- #2 Phillips screwdriver

Hardware bag contents

Component	Component Description	Qty
3040078	MATTRESS RETAINER – Corner	2
4000036	INSERT – Plastic “IV” Socket	4
4000197	HEX SCREW – Cap, PPH, Steel, Zinc Plated – ¼-20 x 1½" *4mm Hex Wrench Included (1)	8
4000207	SCREW – Sheet Metal, PFH, Steel, Zinc Plated – #10-12 x ¾"	1
4010015	CAP INSERT – Flat Head - ¼-20 x 16mm (Honey Bronze)	8
4040025	CLAMP – Adjustable Nylon Cable	1
4920104	CARTON – Bed Hardware	1
5340005	PIN & CABLE – Quick Release Hd/Ft Board	4
5340022BEI	BRACKET – Quick Release Hd/Ft Board, Horizontal (Beige)	4
5340023BEI	BRACKET – Quick Release Hd/Ft Board, Vertical (Beige)	4

Upon receipt of your new bed, carefully inspect the bed and accessory components for any damage received in transit. Notify Direct Supply Customer Service at 1-(855)-324-3656 immediately if any product or component has been damaged or is missing from your shipment.

Wall Bumper

1. With the bed resting on its wheels or rollers, place the bumper in front of the axle of the head-end caster base (*Figure 1*)
2. Place the loops of the bumper so that the Bumper End is positioned next to the Angle Iron and Axle of the head-end caster base (*Figure 2*)
3. Use a rubber mallet to force the bumper ends over the Angle Iron and Axle of the head-end caster base (*Figure 3*)

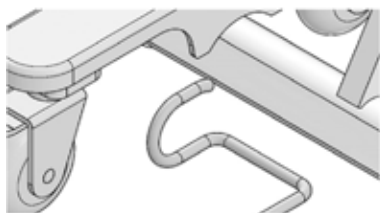

Figure 1

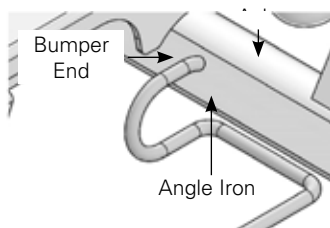

Figure 2

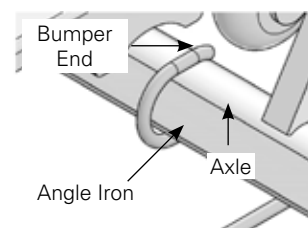
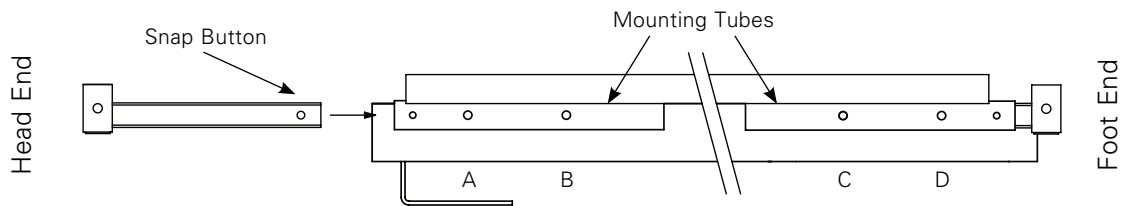

Figure 3

Headboards & Footboards

1. Raise the head and foot decks to increase visibility. On large orders, beds are shipped with transport legs inserted in the headboard mounting tubes. Remove and discard these legs and replace with headboard/footboard brackets. Insert brackets into the mounting tubes until snap buttons align in the holes as indicated below. Ensure snap buttons are seated in the proper holes prior to bed use.



Bed Length	Headboard Bracket Hole	Footboard Bracket Hole
80"	B	C
84"	B	D

2. Normally the cap nuts are installed in the headboards and footboards at the factory. If they are not installed at the factory, insert the cap nuts provided in the hardware bag into the predrilled holes in the headboards and footboards boards using a rubber mallet. If laminated on one side only, install the nuts on the laminated side of the board.

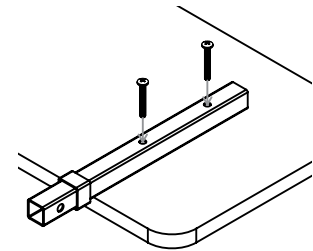

3. Attach vertical brackets to the opposite side of the headboards/footboards using provided screws. Tighten all hardware.

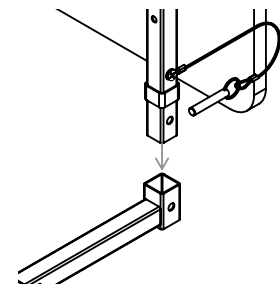

4. Place vertical brackets in horizontal brackets.

5. Slide pin through both brackets to secure.

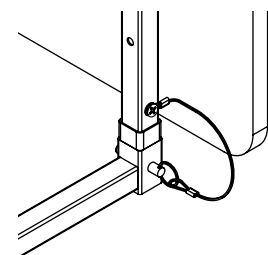

Directions for Use *(cont.)*

Installing the Corner Mattress Retainers

Corner Mattress Retainers (PN 3040078) should be installed at each corner of the bed to assist in maintaining proper alignment of the mattress during bed use. In order for the retainers to be effective, beds should be used in conjunction with a hospital-grade mattress designed to allow bed articulation. The mattress should be 6" thick with a width and length conforming to the sleep deck size. Mattress retainers should be installed prior to installation of any deck-mounted siderails or assist bars.

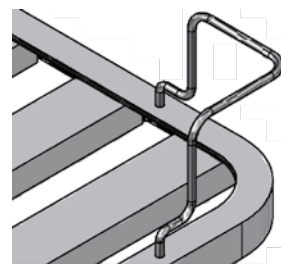
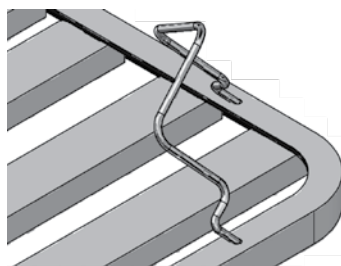
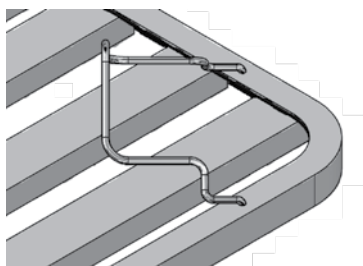

1. Locate two ¼" holes at each bed corner in the outer angle of the head and foot deck. Insert each leg of the Mattress Retainer.
2. With the leg of each side of the Mattress Retainer positioned in the ¼" holes, rotate the Retainer toward the corner of the bed while slowly inserting the legs further into the holes.
3. When fully rotated, press the Mattress Retainer into position and then place the mattress on the rib-deck sleep surface. Check that all corners of the mattress are within the Retainers. A slightly compressed fit is desired.

Ensure the Retainers hold the mattress securely to prevent mattress slippage during head and foot deck articulation.

Install accessory components as per their instructions.

Verify there are no gaps between the mattress, head and foot boards, siderails, or any other accessories wide enough to entrap a resident's head, neck or body. Additional information regarding bed entrapment may be obtained from the U.S. Food and Drug Administration Center for Devices and Radiological Health website.

Your bed is ready for use. The bed should be located and casters locked while the bed is in its lowest position. Adequate spacing must be maintained between the wall and the bed to prevent damage to the bed or walls while raising or lowering the bed. Check to be sure vertical movement of the bed does not interfere with the power cord or plug.

⚠ WARNING: Resident entrapment with assist rails may cause injury or death. To help prevent resident entrapment, you should follow the FDA's entrapment guidance as well as your healthcare provider's recommendation to choose a bed, mattress and accessories that are appropriate for the specific resident. In addition, you should ensure the mattress fits the bed frame and assist rails snugly, follow the manufacturer's instructions for all medical devices and accessories, and monitor the resident frequently.

Additional information regarding bed entrapment may be obtained from the U.S. Food and Drug Administration Center for Devices and Radiological Health website.

Your bed is ready for use. The bed should be positioned and casters locked while the bed is in its lowest position. Adequate spacing must be maintained between the wall and the bed to prevent damage to the bed or walls while raising or lowering the bed. Check to be sure vertical movement of the bed does not interfere with the power cord or plug. Test the bed to ensure it is operating properly prior to each use.

Locating & Connecting the Handset

For convenience, the bed's handset control may be located on either the left or right side of the bed.

As shipped from the factory, the bed has a handset control plugged into a "Y" cable on the resident's left hand side. To relocate the handset to the resident's right side, simply unplug the handset and plug it back into the other end of the "Y" cable on the opposite side of the bed.

Bed Positioning

Bed functions are operated with a 10-button handset. The handset (4040216) is shown to the right. Button functions on the handheld handset control are clearly identified with universal icons. The handset is provided with an attached bracket for suspending the control from assist rails or headboards and footboards. The handset will dim after about a minute has gone by with no buttons pressed. PRIOR TO RAISING OR LOWERING THE BED AND/OR ASSIST RAILS, CHECK TO ENSURE THE CORD FOR THE HANDSET CONTROL HAS NOT BECOME ENTANGLED IN BED PARTS. THE CORD SHOULD BE KEPT CLEAR OF MOVING PARTS AT ALL TIMES.

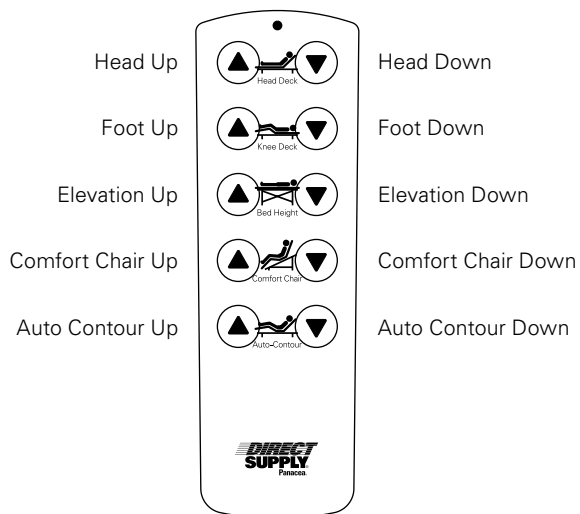

Resetting Bed Positioning

If a bed function appears to be locked out or the bed is not positioning correctly, you may use this procedure to reset your bed's actuator positions. Be sure that no functions are locked out on a staff control before beginning this procedure.

1. Hold the elevation up and down buttons at the same time. Continue to hold until the bed is completely lowered and flat, including head and knee decks.
2. Continue holding buttons for 5 more seconds.
3. Hold button 5 until the bed is completely raised.
4. Your bed has been reset and is ready for use.

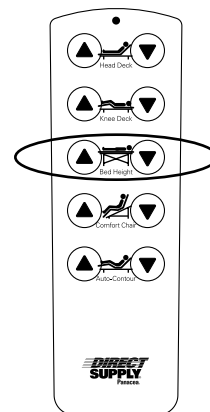

Directions for Use *(cont.)*

Deck Expansion

1. Locate knob under the deck, pull knob down and pull deck out to desired width.
2. Release knob to lock deck into place.
3. Repeat steps 1 and 2 on both sides of each deck.

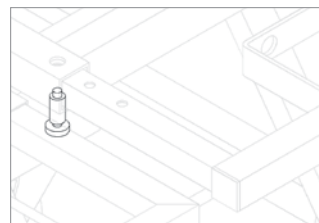
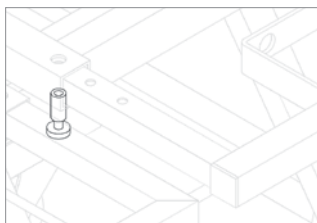
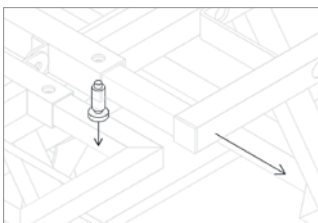

Bed Transport

Move at Any Height

The bed features a patented rolling base that allows it to be rolled or locked at any bed height. In order to lock the bed, activate the brakes located on the twin wheel casters at the foot and head of the bed. To roll the bed, disengage brakes. Activating caster brakes does not disengage bed functions.

⚠ CAUTION:

If casters are not locked, swivel and wheel rotation can allow for bed motion with little or no resistance. This can result in loss of balance, fall and personal injury. Ensure the casters are locked to prevent any bed movement during resident transfer and/or treatment.

⚠ WARNING:

Involuntary bed movement may take place if the bed casters are left unlocked. Involuntary bed movement may lead to property damage or resident injury. Never leave a bed unattended while the casters are unlocked.

⚠ CAUTION:

Moving the bed while the casters are locked may cause damage to the bed. Do not move the bed until the casters are unlocked.

Roll In Low

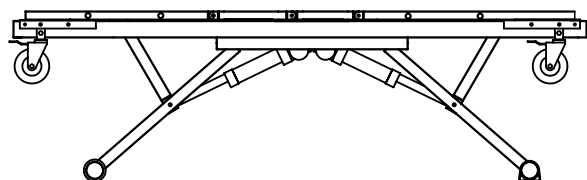

When bed is elevated, it cannot be moved.

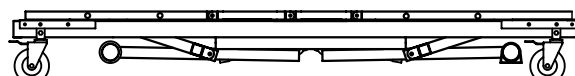

When bed is in its lowest position, it can be moved.

Accessories & Options

Optional Battery Backup

An optional battery backup is available (PN 7540068). In the event of a power failure, the control box provides a power down feature that enables lowering the bed without AC power.

The battery will begin charging as soon as unit is plugged into 120V AC power. The battery backup will work automatically when AC power is lost.

Optional Footboard Control

An optional lockout footboard control with subacute functions is available.

Safety Lock

For mobile-at-any-height beds only, an optional safety lock is available to provide easy, one-touch locking of the foot end of your Panacea 3500 Bed. This option is available for purchase only at the time of bed purchase.

Free-standing Trapeze

A freestanding trapeze is available to allow residents to assist themselves with repositioning.

Overbed Trapeze

An overbed trapeze that mounts directly onto the bed is available to allow residents to assist themselves with repositioning.

Accessories and Options *(cont.)*

Panacea® Advanced Staff Control Kit











The Nurse Panel (4040368) is plugged into the Nurse Panel Cable. The Nurse Panel Cable is plugged into the Junction Y-Cable (located on the bed frame).

After the Nurse Panel is connected properly (see Control Box Diagram), press the power button to make sure the screen comes on. When active, the lights by the position and locking buttons will be off. A GREEN light by the position button indicates which function will be used. A GREEN light by the locking symbol indicates that the function is locked. The nurse panel will turn off after no buttons have been pressed for 30 seconds. PRIOR TO RAISING OR LOWERING THE BED AND/OR ASSIST DEVICES, CHECK TO ENSURE THE CORD FOR THE NURSE PANEL HAS NOT BECOME ENTANGLED IN BED PARTS. THE CORD SHOULD BE KEPT CLEAR OF MOVING PARTS AT ALL TIMES.

⚠ WARNING: Height and angle readouts are for comfort positioning only. Do not use angle readouts for monitoring head deck angle for use with feeding tubes. Do not use height and angle readouts for setting clinical positioning or for taking measurements. Readouts are intended only to aid residents and caregivers in setting the bed for optimal comfort and resident preference.

⚠ WARNING: Height and angle readouts may change slightly over time due to actuator wear, metal fatigue or other conditions. Do not use the height or angle functionality on the advanced staff control for monitoring clinical positioning, including setting the head deck angle for use with feeding tubes.



-  Power
-  Up
-  Down
-  Hi/Lo
-  Comfort Chair
-  Auto Contour
-  Lock
-  Head
-  Foot
-  Trendelenburg
-  Underbed Light

Installing the Nurse Panel Holder

Required Parts:

- (1) 4040345 – Holder – Nurse Panel
- (2) 4020008 – Screw – Drill & Tap, PPH, Steel, Zinc Plated – #10-16 x ¾"

1. Place the Nurse Panel inside the bronze insert on left side of the footboard when standing on the foot end of the bed, with the top of the Nurse Panel holder about 4" from the top of the footboard.
2. Use two screws to secure the Nurse Panel holder to the footboard.



Servicing

⚠ WARNING: DO NOT perform any service or maintenance while resident is in bed.

⚠ WARNING: All replacement of parts must be completed by qualified service personnel.

Troubleshooting

Symptom	Possible Cause(s)	Action
No power/green power indicating light not on	<ol style="list-style-type: none"> 1. Bed is not plugged into AC power. 2. Power cord is cut/damaged. 3. Loose plug for handset. Cut/damaged handset cord. 4. Actuator plug not connected. 	<ol style="list-style-type: none"> 1. Check plug to receptacle. 2. Check power cord for damage. 3. Have qualified technician check 115V outlet.
Actuators operate, but the wrong movement occurs	<ol style="list-style-type: none"> 1. Cut/damaged handset cord. 2. Damaged/defective Y-cable. 	<ol style="list-style-type: none"> 1. Inspect handset cord for damage. 2. Unplug the Y-cable and plug the handset directly into the control box.
One or more actuators do not function	<ol style="list-style-type: none"> 1. Loose or unplugged connection of actuator cord to control box. 2. Cut/damaged actuator cord. 3. Defective actuator. 4. Defective control box. 5. Damaged/defective Y-cable. 6. Function is locked out on a staff control panel (optional – located at the footboard of the bed). 7. An actuator is out of position. 	<ol style="list-style-type: none"> 1. Check actuator plug to control box. 2. Inspect actuator cord for damage. 3. Replace actuator. 4. Replace control box. 5. Unplug the Y-cable and plug the handset directly into the control box port. 6. Unlock all functions on the staff control panel, if installed. 7. Perform the bed reset function shown on page 11 of this manual.
Bed is not level when operating Hi-Low functions	<ol style="list-style-type: none"> 1. Actuators are out of synchronization. 2. Damaged/defective Y-cable. 	<ol style="list-style-type: none"> 1. Run bed to full down position and continue to hold button for 3 seconds (after bed reaches full down position). 2. Unplug the t-cable and plug the handset directly into the control box port.

Steps for Isolating Electrical Problems

1. Check all connections.
2. Exchange handset with a known working handset.
3. Exchange actuator plugs at known working control box ports.
4. Check actuator with a known working control box.

IF USE OF THIS TROUBLESHOOTING GUIDE DOES NOT CORRECT THE PROBLEM, PLEASE CONTACT DIRECT SUPPLY EQUIPMENT & FURNISHINGS®.

Troubleshooting

Symptom	Possible Cause(s)	Action
Excessive creaking/ noise	<ol style="list-style-type: none"> 1. Pivot points need lubrication 2. Bolts backing out 3. Areas with excessive wear 4. Areas with rust due to exposure to liquids 5. Welds cracked 	<ol style="list-style-type: none"> 1. Lubricate pivot points: <ol style="list-style-type: none"> a. WARNINGS: <ol style="list-style-type: none"> i. Never service the bed with a resident in bed. ii. Unplug bed before servicing. iii. Before servicing, move the bed to a safe area with room to work. iv. Bed must be tipped on its side in order to service actuator pivot points. Bed is heavy – team lift required to tip onto side. v. Do not apply lubrication to the bed’s surface b. Remove actuator pins. c. Clean pins and holes with a mild cleaning agent. d. Apply a food-grade, silicone-based grease to the pins and holes. WARNING do not use WD-40 or other solvents as lubricant. Clear or white silicone-based grease, especially containing PTFE, is ideal. e. Replace actuator pins and secure with locking cotter pins. Do not apply lubrication to bolts, and do not apply lubrication to the bed surface f. Turn bed upright, plug back into wall, and test all functions before allowing residents to use the bed. 2. Tighten loose bolts <ol style="list-style-type: none"> a. WARNINGS: <ol style="list-style-type: none"> i. Never service the bed with a resident in bed. ii. Unplug bed before servicing. iii. Before servicing, move the bed to a safe area with room to work. iv. Bed must be tipped on its side in order to service actuator pivot points. Bed is heavy – team lift required to tip onto side. v. Do not apply lubrication to bolts vi. Do not apply lubrication to the bed’s surface vii. Do not over-tighten bolts at pivot points 3. The bed has a Safe Working Load of 600 pounds. Ensure that all the total weight on the bed, including the patient, mattress, bedding, and all accessories, does not exceed the Safe Working Load. Inspect all welds for cracks and inspect all bolts and fasteners. Contact DS Tech Support for replacement parts 4. Contact DS Tech Support for replacement parts. 5. Warning - Discontinue use of the bed until welds are serviced. Contact DS Tech Support for replacement parts.

Servicing (cont.)

Control Box Socket Identification

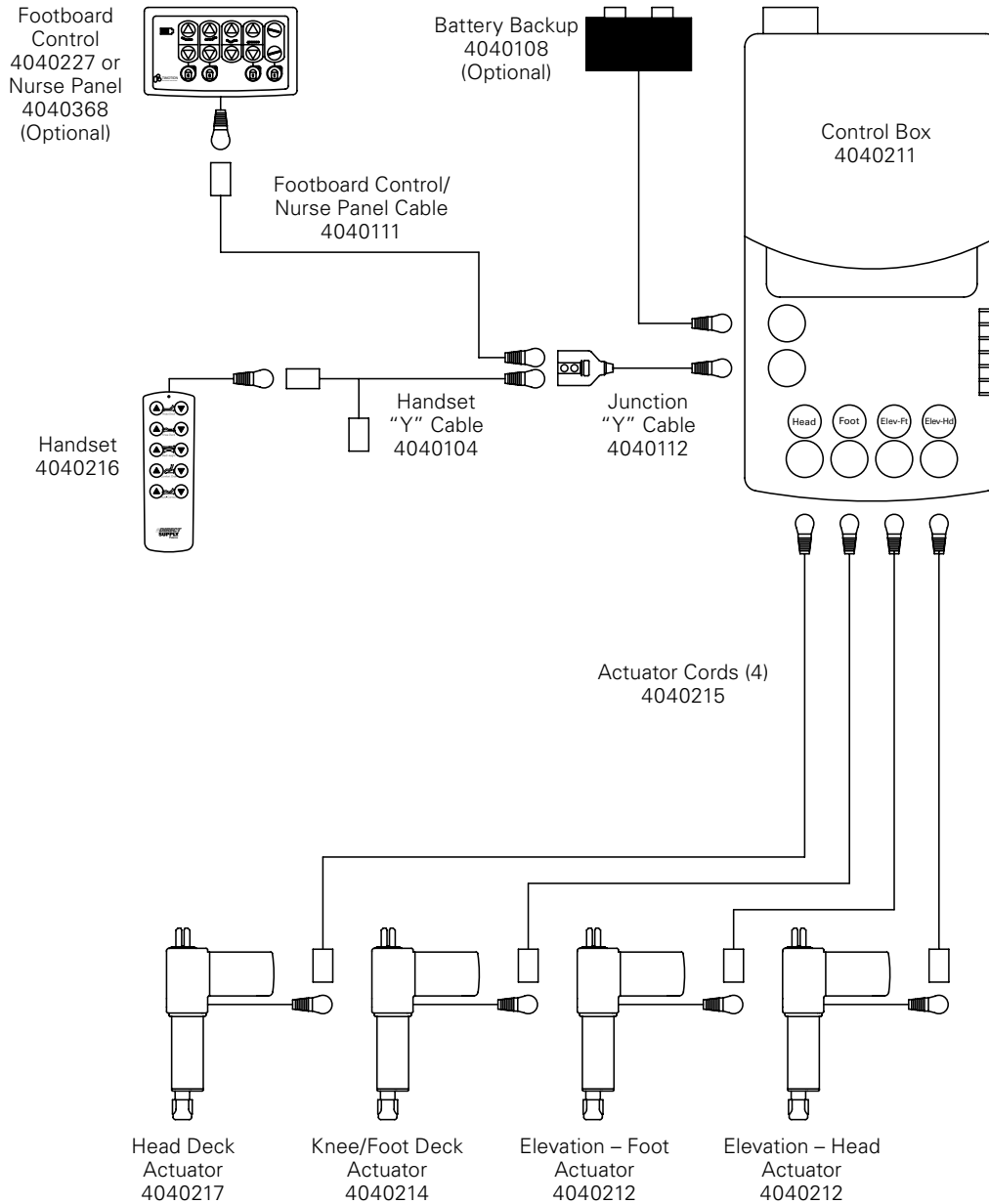

Replacement of Power Cord

⚠ CAUTION: Unplug bed before beginning work.

⚠ WARNING: Inappropriate handling of the POWER CORD, e.g. by kinking, shearing or other mechanical damages, may cause injury or death.

The power cord should only be replaced with a genuine Panacea listed power cord (PN 4040147) by qualified service personnel.

Bed Diagram – Roll In Low

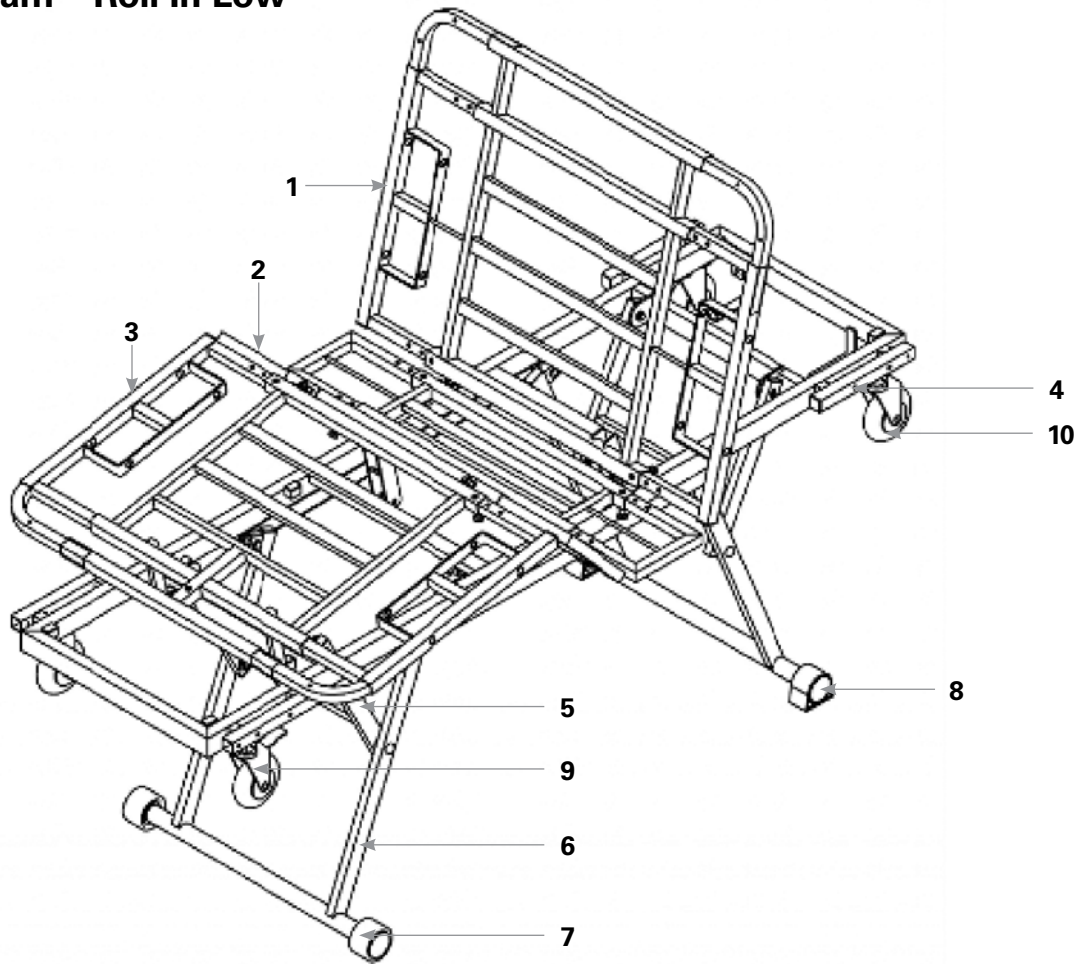

Parts List

Item No.	Part Number	Qty.	Description
1	5170018BEI	1	Head Deck
2	5170019BEI	1	Knee Deck
3	5170020BEI	1	Foot Deck
4	5170014BEI	1	Frame
5	5170022BEI	1	Arm
6	5170027BEI	1	Leg
7	4040339	2	Support Roller
8	4040338	2	Support Pad
9	4040336	2	Nonlocking Caster
10	4040337	2	Locking Caster
N.P.	4040216	1	Handset
N.P.	3040078	2	Corner Mattress Retainer

Item No.	Part Number	Qty.	Description
N.P.	5340023BEI	4	Vertical Bracket
N.P.	5340022BEI	4	Horizontal Bracket
N.P.	4040211	1	Control Box
N.P.	4040212	2	Actuator – Elevation
N.P.	4040217	1	Actuator – Head
N.P.	4040214	1	Actuator – Foot
N.P.	4040215	4	Actuator Cord – 48"
N.P.	4040081	1	Strain Relief
N.P.	4040104	1	Handset "Y" Cable
N.P.	4040112	1	Junction "Y" Cable
N.P.	4040111	1	Footboard Cable
N.P.	7540136	1	Leg & Caster Base w/ Safety Lock (optional)

NOTE: N.P. - Not Pictured

Servicing *(cont.)*

Bed Diagram – Move at Any Height

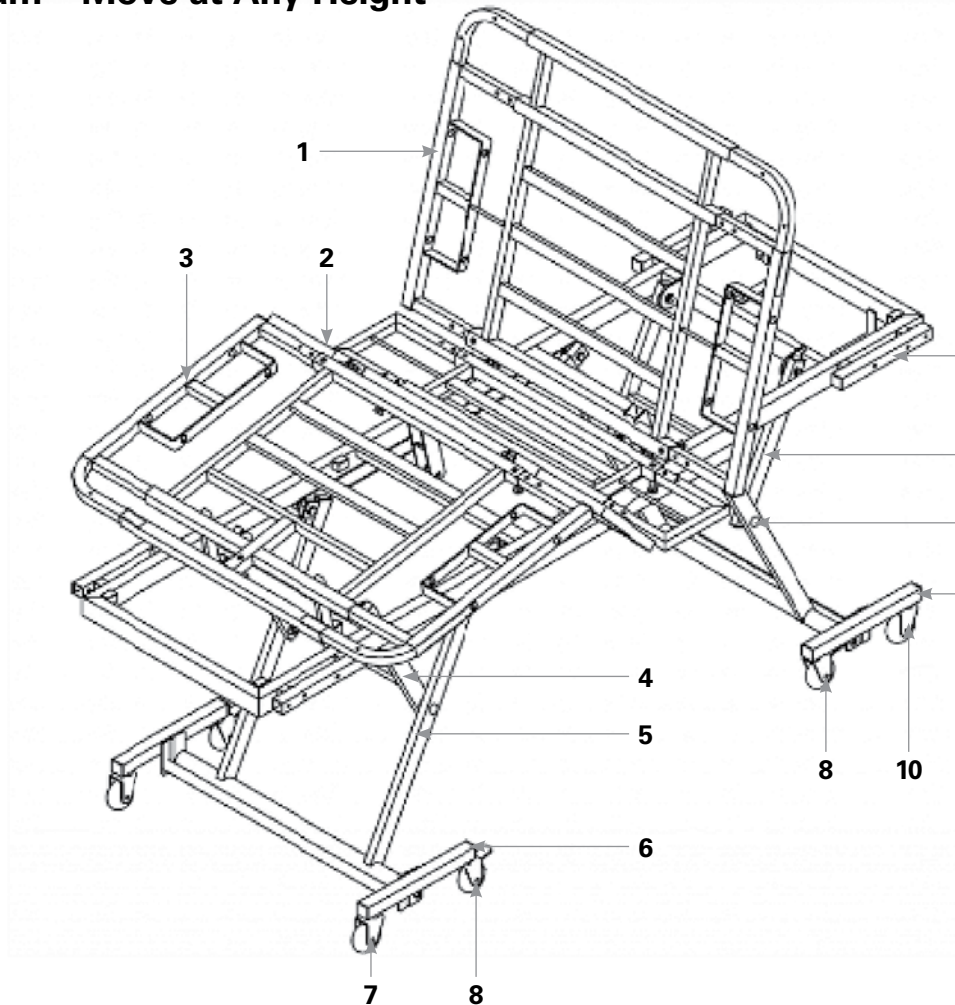

Parts List

Item No.	Part Number	Qty.	Description
1	5170018BEI	1	Head Deck
2	5170019BEI	1	Knee Deck
3	5170020BEI	1	Foot Deck
4	5170022BEI	2	Arm
5	5170024BEI	2	Leg
6	5240174BEI	2	Caster Base
7	4040340	2	Nonlocking Caster
8	4040341	4	Locking Caster
9	5170014BEI	1	Frame
10	4040342	2	Steering Caster
N.P.	4040216	1	Handset
N.P.	3040078	2	Corner Mattress Retainer

Item No.	Part Number	Qty.	Description
N.P.	5340023BEI	4	Vertical Bracket
N.P.	5340022BEI	4	Horizontal Bracket
N.P.	4040211	1	Control Box
N.P.	4040212	2	Actuator – Elevation
N.P.	4040217	1	Actuator – Head
N.P.	4040214	1	Actuator – Foot
N.P.	4040215	4	Actuator Cord – 48"
N.P.	4040081	1	Strain Relief
N.P.	4040104	1	Handset "Y" Cable
N.P.	4040112	1	Junction "Y" Cable
N.P.	4040111	1	Footboard Cable

NOTE: N.P. - Not Pictured

Cleaning and Periodic Inspection

Cleaning Method

⚠ WARNING: NEVER perform maintenance with a resident on or near the device. Only qualified personnel should attempt to perform maintenance on this bed. Failure to properly follow all warnings and instructions may result in personal injury or damage to the device. Failure to properly care for the device may decrease the device life and increase the need for maintenance.

Cleaning Instructions

- ⚠ WARNING:** Always unplug the bed from the power supply prior to cleaning.
- Make sure all electrical parts (motors, control boxes and pendant) are not broken and all housing components are unplugged. Ensure NO liquids enter electrical components.
 - Sanitize and wash all components. DO NOT submerge the bed frame or electrical components.
 - Use standard water pressure. DO NOT power wash or steam clean any parts.
 - Rinse completely with water (maximum temperature 110°F or 43°C). Solvents, alcohol or petroleum should not be used on the bed surface.
 - Do not allow water to spill or drip onto any wiring, controls or actuators.
 - Make sure all parts are dry before using or storing.

Periodic Inspection

1. Perform the procedure “STEPS TO PREVENT BED FIRES” listed in this manual.
2. Review “REDUCING THE RISK OF ENTRAPMENT” listed in this manual.
3. Review and inspect for compliance to the “WARNINGS” listed in this manual.
4. Check casters to ensure they lock, if applicable, and roll properly.
5. Inspect all bed components for damage or excessive wear.
6. Visually examine all welds for cracks.
7. Inspect the deck components for bending or damage.
8. Check the motor actuator shaft and its connections for bending, damage or excessive wear.
9. Check actuator ends and its mounting hardware for bending or excessive wear.
10. Inspect all bolts and fasteners (Do not over tighten bolts at pivot points).
11. Check all cords for cuts or other damage.
12. Make sure all plugs are fully seated.
13. Make sure all cords are free of moving parts.
14. Visually examine all components for damage or excessive wear, cracked or missing brake pads. Make sure e-rings and pins are secure.
15. Check that brake pads are intact and offer sufficient resistance to hold the bed securely with a horizontal force of 65 pounds. If this test fails, it is recommended that the brake pads be replaced.

Limited Warranty

We offer to you, as the original purchaser, a warranty for the Panacea 3500 Bed. Our warranty applies for the limited warranty period stated below. If any device or device part listed below is defective in material or workmanship during the applicable limited warranty period, we will repair or replace it at our cost. Please note that the decision to repair or replace a device or device part will be at our discretion. Our warranty applies only if the device is properly maintained by the original purchaser for normal, indoor use and does not cover normal wear and tear, modification of the device or damage caused by abuse, improper use, failure to maintain, use which exceeds the published device limitations or the combination of any device with another product. In addition, our warranty does not cover fading, colorfastness, stains, spills or exposure to chemicals, odors, heat or light. In certain cases, we may provide you repair or adjustment instructions and/or replacement parts, and ask you to perform a repair or adjustment or replace a defective part.

Our warranty gives you specific legal rights, and you may also have other rights, which vary from state to state. Please note that our limited warranty period begins when we ship the device to you. The limited warranty period and our obligations under the warranty end once you transfer the device to someone else, or at the end of the applicable limited warranty period identified below, whichever is earlier.

		Warranty Period (Parts Only)	Anticipated Usable Device Life
Welds	Welds	Lifetime	Lifetime
Frame	Frame, caster base, safety lock	15 years	15 years
Electronics	Actuator, control box, pendant, staff control	4 years	4 years
Accessories	Assists, casters, panels, width kit	3 years	3 years

Anticipated Usable Device Life is based on normal use with proper maintenance, cleaning and storage. You should still inspect, monitor and care for the device as described in this guide, as the device may need to be replaced sooner than anticipated in particular situations.

DIRECT SUPPLY MANUFACTURING, INC. MAKES NO IMPLIED WARRANTIES OF MERCHANTABILITY OR FITNESS FOR A PARTICULAR PURPOSE; THESE AND ALL OTHER IMPLIED WARRANTIES ARE SPECIFICALLY DISCLAIMED. TO THE FULLEST EXTENT ALLOWED BY LAW, DIRECT SUPPLY MANUFACTURING, INC. WILL NOT BE LIABLE FOR ANY INCIDENTAL, SPECIAL, CONSEQUENTIAL OR PUNITIVE DAMAGES, OR LOST PROFITS THAT MAY RESULT FROM THE DEVICE OR YOUR USE OF OR INABILITY TO USE THE DEVICE EVEN IF ADVISED OF THE POSSIBILITY OF SUCH DAMAGES. OUR TOTAL LIABILITY TO YOU, IF ANY, IS LIMITED TO THE PRICE OF THE DEVICE OR SERVICE GIVING RISE TO YOUR CLAIM. Some states do not allow an exclusion or limitation of incidental or consequential damages, or how long an implied warranty lasts, so the above limitations or exclusions may not apply to you. If implied warranties are not excluded, and to the extent allowed by law, we limit any and all implied warranties to the applicable warranty period identified above. Except for rights under any applicable state law, the remedies provided under this warranty are your sole and exclusive remedy for any breach of our warranty and state the entire limit of our responsibilities.

Customer Service

Our promise to you is that you will have a convenient and easy ordering experience, receive a quality Panacea 3500 Bed and enjoy outrageous customer service. If you have any questions about the bed you have purchased or would like to request warranty service, please contact: **Direct Supply Equipment & Furnishings** at 1-800-634-7328, 6767 N. Industrial Road, Milwaukee, WI 53223, SalesSupport@DirectSupply.com.



DirectSupply.com

APTURA / EQUIPMENT & FURNISHINGS / DSSI / TELS

Distributed by Direct Supply Manufacturing, Inc. 6635 N Industrial Road, Milwaukee, WI 53223.

© 2015-2022 Direct Supply Manufacturing, Inc. All Rights Reserved. Direct Supply®, Panacea®, and all associated logos are the registered trademarks of Direct Supply, Inc., used under license.